

THE PROPERTY OF THE DRAWING IS ESTABLISHED BY LAW. IT IS FORBIDDEN TO PRODUCE OR SHOW IT TO THIRD PARTY, WITHOUT A WRITTEN AGREEMENT.

Item	Name	Q.ty
1	WSL.GA.20.1.SL	1
2	WSL.GA.20.2	1
3	R.6.SCH	2
4	V.TCE6x25	2

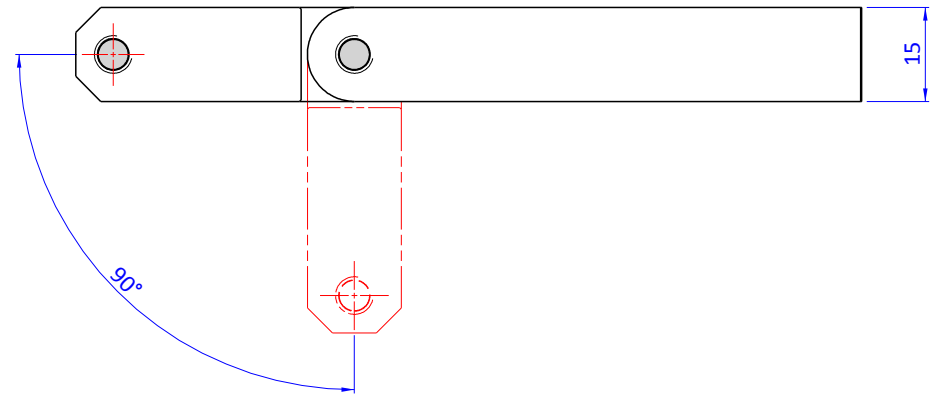
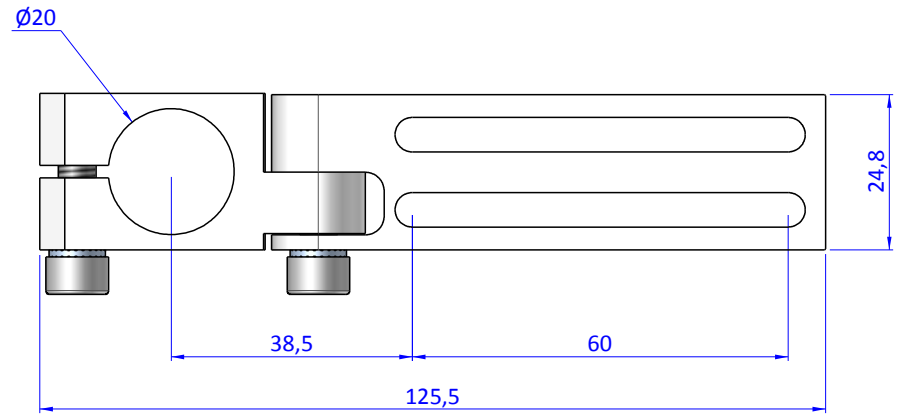
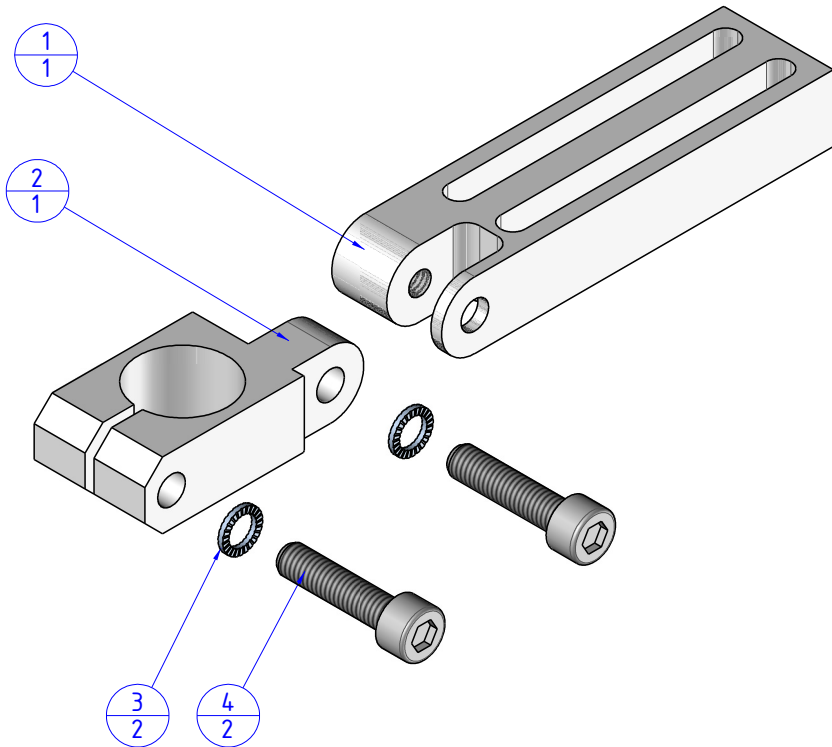

Format A3

UNI 936-76

<b>FP SERVICES</b> AUTOMATION		DESIGNED FROM FPSERVICES		REVIEW A
GENERAL TOLERANCE UNI - ISO 2768 CLASSE f		DATE 16/11/2018	WEIGHT 0,095kg	
		CODE CA.WSL.GA.20		